

	Achilles, A.	Himstedt, J.	Ostermann, C.	Müller, H.
Achilles, A.		21/16,16/21,21/16	22/20,21/15	21/11,21/12
Himstedt, J.	16/21,21/16,16/21		21/11,21/17	21/16,21/11
Ostermann, C.	20/22,15/21	11/21,17/21		21/18,21/13
Müller, H.	11/21,12/21	16/21,11/21	18/21,13/21	
Punkte	143 : 111	137 : 113	105 : 116	81 : 126
Sätze	6 : 1	5 : 2	2 : 4	0 : 6
Spiele	3 : 0	2 : 1	1 : 2	0 : 3
Platz	1.	2.	3.	4.

1. Runde	1. Achilles, Alicia	4. Müller, Hannah	21/11,21/12
	2. Himstedt, Jeldrik	3. Ostermann, Carlo	21/11,21/17
2. Runde	Himstedt, Jeldrik	Müller, Hannah	21/16,21/11
	Ostermann, Carlo	Achilles, Alicia	20/22,15/21
3. Runde	Müller, Hannah	Ostermann, Carlo	18/21,13/21
	Achilles, Alicia	Himstedt, Jeldrik	21/16,16/21,21/16

Stadtmeisterschaften BS 2011 - MD+JD U11

1. Achilles, A./Müller, H.

4. Rast

Achilles, A./Müller, H.

a

3. Rast

2. Himstedt, J./Ostermann, C.

Himstedt, J./Ostermann, C.

b

Himstedt, J./Ostermann, C.

2.

18/21,21/9,21/19 1.

Rast

A

Rast

4.

3.

Rast

B

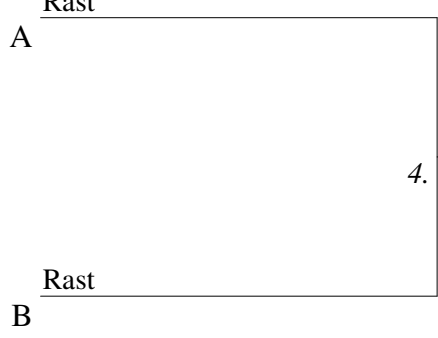
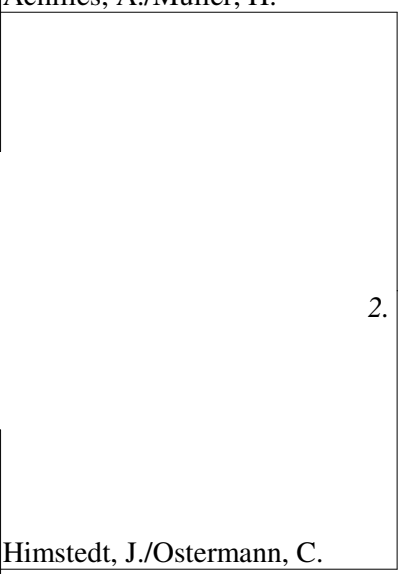
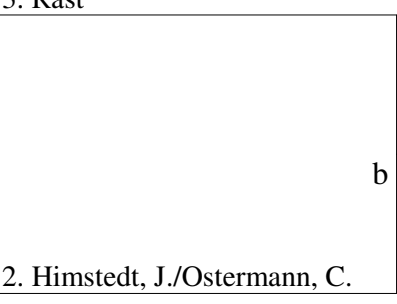
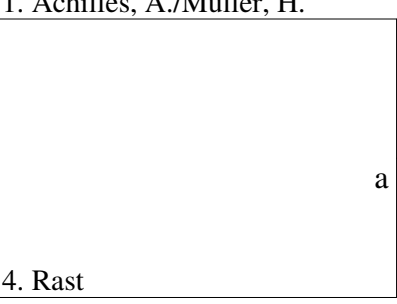

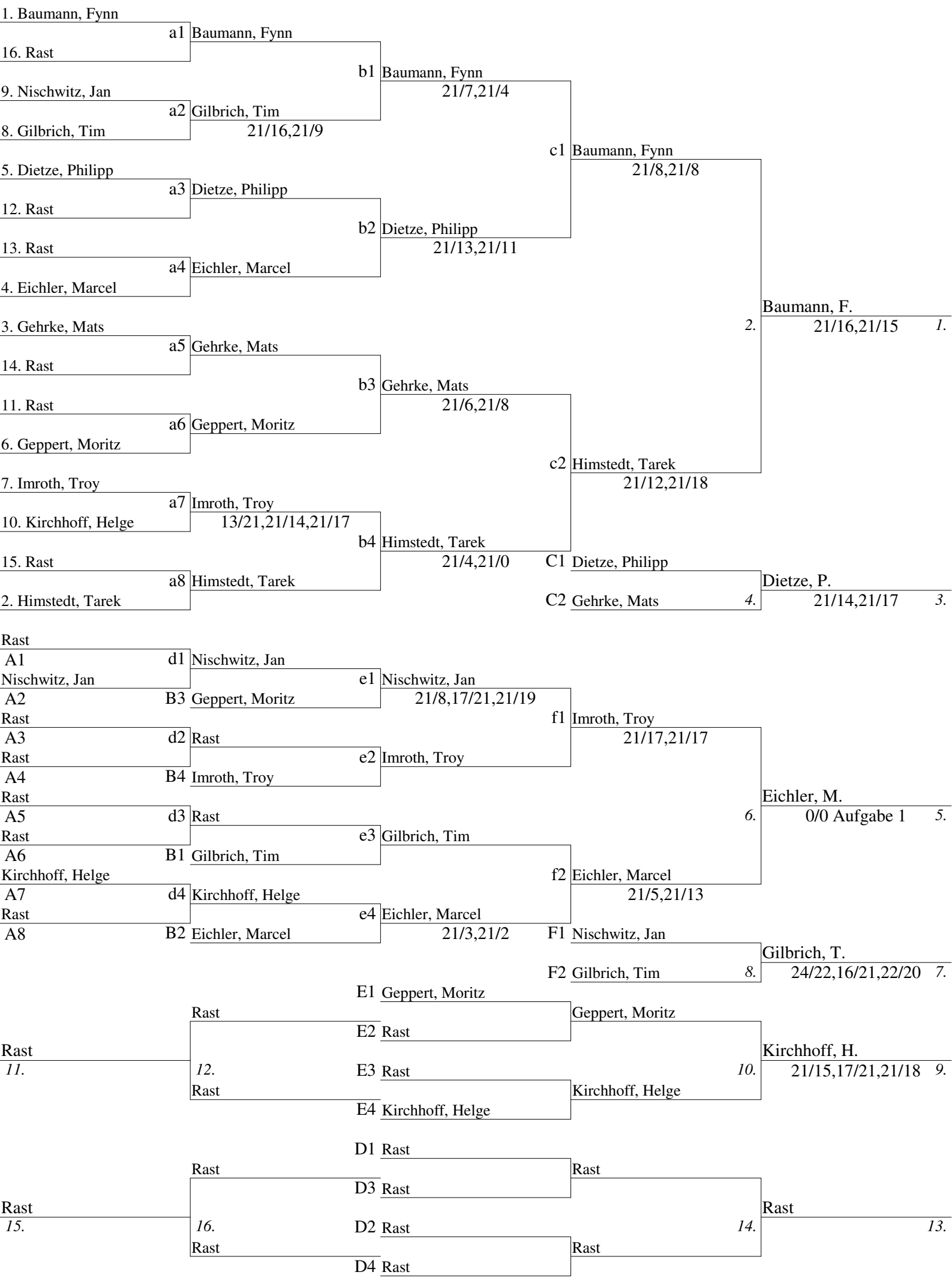

1. Jürgens, Serena

a Jürgens, Serena

8. Rast

e Jürgens, Serena

21/5,21/7

5. Passoke, Ariane

b Voges, Melissa

21/17,16/21,21/9

4. Voges, Melissa

Jürgens, X.

2. 15/21,21/11,21/11 1.

3. Focken, Nele

c Focken, Nele

21/6,21/14

6. Kumpf, Janine

f Jürgens, Xenia

21/4,21/7

7. Schütz, Anna

d Jürgens, Xenia

21/6,21/11

2. Jürgens, Xenia

Rast

A

g Kumpf, Janine

Kumpf, Janine

C

E Voges, Melissa

i Voges, Melissa

15/2 Aufgabe 1

Passoke, Ariane

B

h Schütz, Anna

21/9,21/14

Schütz, Anna

D

F Focken, Nele

j Schütz, Anna

21/18,21/4

Voges, M.

4. 21/19,21/18 3.

I Kumpf, Janine

Focken, N.

6. kampflös 5.

J Focken, Nele

G Rast

Passoke, A.

8. 7.

H Passoke, Ariane

	Jürgens, S./Jürgens, X.	Himstedt, T./Gehrke, M.	Baumann, F./Goralczyk, M.	Dietze, P./Geppert, M.	Eichler, M./Nischwitz, J.	Rast
Jürgens, S./Jürgens, X.	21/15,21/17	21/14,21/10	21/9,21/6	21/13,21/9		
Himstedt, T./Gehrke, M.	15/21,17/21	21/14,19/21,14/21	22/20,21/11	21/10,21/17		
Baumann, F./Goralczyk, M.	14/21,10/21	14/21,21/19,21/14	21/23,21/10,21/9	21/15,21/9		
Dietze, P./Geppert, M.	9/21,6/21	20/22,11/21	23/21,10/21,9/21	21/18,18/21,21/15		
Eichler, M./Nischwitz, J.	13/21,9/21	10/21,17/21	15/21,9/21	18/21,21/18,15/21		
Rast						
Punkte	168 : 93	171 : 156	185 : 162	148 : 202	127 : 186	
Sätze	8 : 0	5 : 4	6 : 4	3 : 7	1 : 8	
Spiele	4 : 0	2 : 2	3 : 1	1 : 3	0 : 4	
Platz	1.	3.	2.	4.	5.	

1. Runde	1. Jürgens, S./Jürgens, X.	6. Rast	
	2. Himstedt, T./Gehrke, M.	5. Eichler, M./Nischwitz, J.	21/10,21/17
	3. Baumann, F./Goralczyk, M.	4. Dietze, P./Geppert, M.	21/23,21/10,21/9
2. Runde	Baumann, F./Goralczyk, M.	Rast	
	Dietze, P./Geppert, M.	Himstedt, T./Gehrke, M.	20/22,11/21
	Eichler, M./Nischwitz, J.	Jürgens, S./Jürgens, X.	13/21,9/21
3. Runde	Rast	Eichler, M./Nischwitz, J.	
	Jürgens, S./Jürgens, X.	Dietze, P./Geppert, M.	21/9,21/6
	Himstedt, T./Gehrke, M.	Baumann, F./Goralczyk, M.	21/14,19/21,14/21
4. Runde	Himstedt, T./Gehrke, M.	Rast	
	Baumann, F./Goralczyk, M.	Jürgens, S./Jürgens, X.	14/21,10/21
	Dietze, P./Geppert, M.	Eichler, M./Nischwitz, J.	21/18,18/21,21/15
5. Runde	Rast	Dietze, P./Geppert, M.	
	Eichler, M./Nischwitz, J.	Baumann, F./Goralczyk, M.	15/21,9/21
	Jürgens, S./Jürgens, X.	Himstedt, T./Gehrke, M.	21/15,21/17

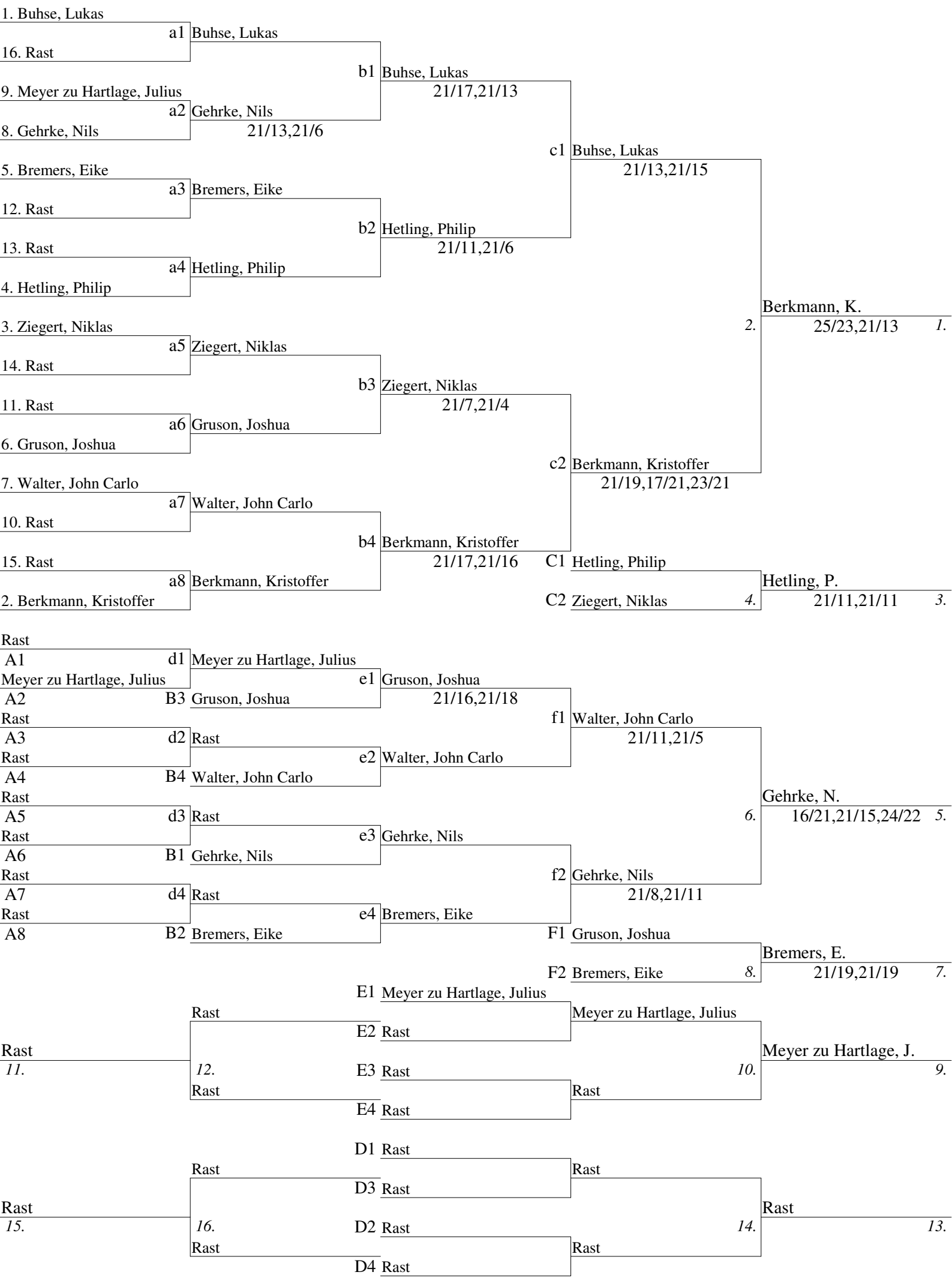

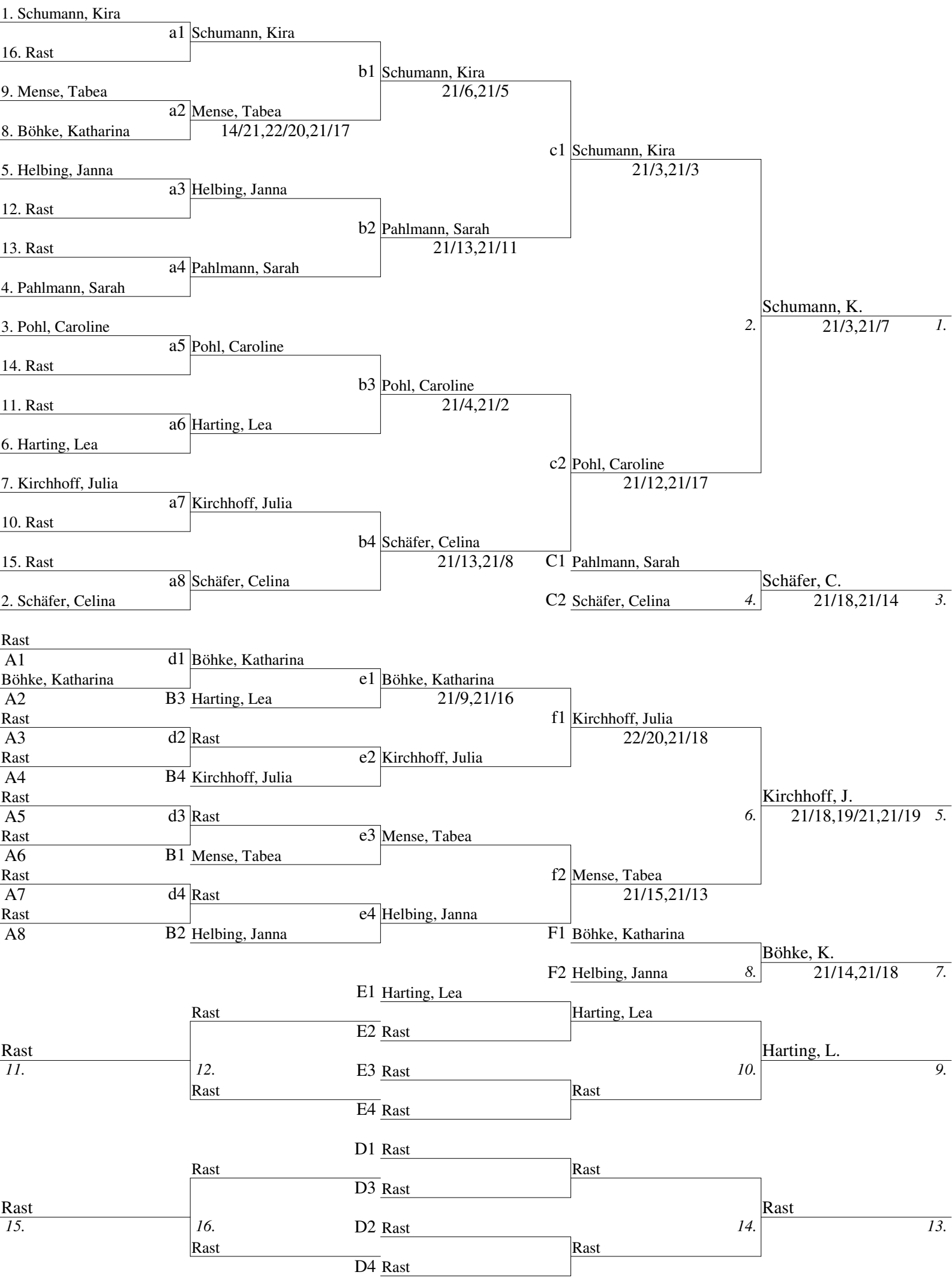

	Berkmann, K./Buhse, L.	Kirchhoff, H./Bremers, E.	Meyer zu Hartlage, J./Gruson, J.	Gehrke, N./Walter, J.
Berkmann, K./Buhse, L.		21/6,21/10	21/11,21/8	21/16,21/19
Kirchhoff, H./Bremers, E.	6/21,10/21		21/18,13/21,14/21	6/21,11/21
Meyer zu Hartlage, J./Gruson, J.	11/21,8/21	18/21,21/13,21/14		11/21,19/21
Gehrke, N./Walter, J.	16/21,19/21	21/6,21/11	21/11,21/19	
Punkte	126 : 70	81 : 144	109 : 132	119 : 89
Sätze	6 : 0	1 : 6	2 : 5	4 : 2
Spiele	3 : 0	0 : 3	1 : 2	2 : 1
Platz	1.	4.	3.	2.

1. Runde	1. Berkmann, K./Buhse, L.	4. Gehrke, N./Walter, J.	21/16,21/19
	2. Kirchhoff, H./Bremers, E.	3. Meyer zu Hartlage, J./Gruson, J.	21/18,13/21,14/21
2. Runde	Kirchhoff, H./Bremers, E.	Gehrke, N./Walter, J.	6/21,11/21
	Meyer zu Hartlage, J./Gruson, J.	Berkmann, K./Buhse, L.	11/21,8/21
3. Runde	Gehrke, N./Walter, J.	Meyer zu Hartlage, J./Gruson, J.	21/11,21/19
	Berkmann, K./Buhse, L.	Kirchhoff, H./Bremers, E.	21/6,21/10

Stadtmeisterschaften BS 2011 - MD U15

Ausrichter : Badminton SFV BS e.V.

	Pahlmann, S./Voges, M.	Harting, L./Böhke, K.	Kirchhoff, J./Helbing, J.
Pahlmann, S./Voges, M.		21/5,21/5	21/15,21/15
Harting, L./Böhke, K.	5/21,5/21		16/21,23/21,21/16
Kirchhoff, J./Helbing, J.	15/21,15/21	21/16,21/23,16/21	
Punkte	84 : 40	70 : 100	88 : 102
Sätze	4 : 0	2 : 3	1 : 4
Spiele	2 : 0	1 : 1	0 : 2
Platz	1.	2.	3.

1. Runde	1. Pahlmann, S./Voges, M.	3. Kirchhoff, J./Helbing, J.	21/15,21/15
2. Runde	2. Harting, L./Böhke, K.	3. Kirchhoff, J./Helbing, J.	16/21,23/21,21/16
3. Runde	1. Pahlmann, S./Voges, M.	2. Harting, L./Böhke, K.	21/5,21/5

	Ziegert, N./Mense, T.	Gruson, J./Voges, M.	Meyer zu Hartlage, J./Pahlmann, S.	Walter, J./Böhke, K.	Dietze, P./Harting, L.	Grundmann, T./Päucker, B.
Ziegert, N./Mense, T.	11/21,17/21	21/11,21/17	21/10,21/17	21/13,16/21,18/21	21/19,16/21,19/21	21/9,11/21,21/18
Gruson, J./Voges, M.	21/16,21/11	21/17,21/10	19/21,21/16,21/19	16/21,11/21	21/19,21/10	16/21,21/15,16/21
Meyer zu Hartlage, J./Pahlmann, S.	8/21,21/19,14/21	21/19,21/19	9/21,21/11,18/21	19/21,10/21	21/10,21/9	10/21,9/21
Walter, J./Böhke, K.	21/8,21/11	21/12,21/5	21/13,21/12	21/16,15/21,21/16	21/10,21/9	
Dietze, P./Harting, L.	204 : 210	137 : 210	231 : 233	240 : 196	181 : 236	225 : 133
Grundmann, T./Päucker, B.	5 : 7	0 : 10	7 : 6	9 : 3	4 : 8	10 : 1
Punkte	2 : 3	0 : 5	3 : 2	4 : 1	1 : 4	5 : 0
Sätze	4.	6.	3.	2.	5.	1.
Spiele						
Platz						

1. Runde	1. Ziegert, N./Mense, T.	6. Grundmann, T./Päucker, B.	8/21,11/21
	2. Gruson, J./Voges, M.	5. Dietze, P./Harting, L.	19/21,19/21
	3. Meyer zu Hartlage, J./Pahlmann, S.	4. Walter, J./Böhke, K.	21/19,16/21,19/21
2. Runde	Meyer zu Hartlage, J./Pahlmann, S.	Grundmann, T./Päucker, B.	13/21,12/21
	Walter, J./Böhke, K.	Gruson, J./Voges, M.	21/17,21/10
	Dietze, P./Harting, L.	Ziegert, N./Mense, T.	8/21,21/19,14/21
3. Runde	Grundmann, T./Päucker, B.	Dietze, P./Harting, L.	21/10,21/9
	Ziegert, N./Mense, T.	Walter, J./Böhke, K.	16/21,11/21
	Gruson, J./Voges, M.	Meyer zu Hartlage, J./Pahlmann, S.	10/21,17/21
4. Runde	Gruson, J./Voges, M.	Grundmann, T./Päucker, B.	12/21,5/21
	Meyer zu Hartlage, J./Pahlmann, S.	Ziegert, N./Mense, T.	13/21,21/16,21/18
	Walter, J./Böhke, K.	Dietze, P./Harting, L.	21/19,21/10
5. Runde	Grundmann, T./Päucker, B.	Walter, J./Böhke, K.	21/16,15/21,21/16
	Dietze, P./Harting, L.	Meyer zu Hartlage, J./Pahlmann, S.	9/21,21/11,18/21
	Ziegert, N./Mense, T.	Gruson, J./Voges, M.	21/11,21/17

1. Draba, Siegfried

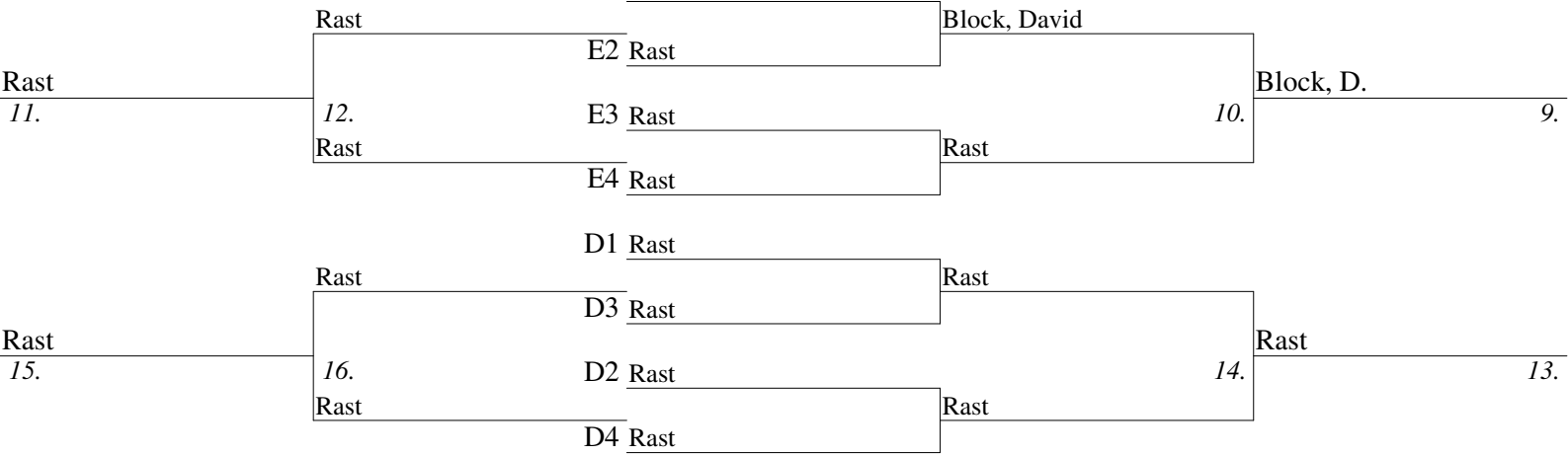
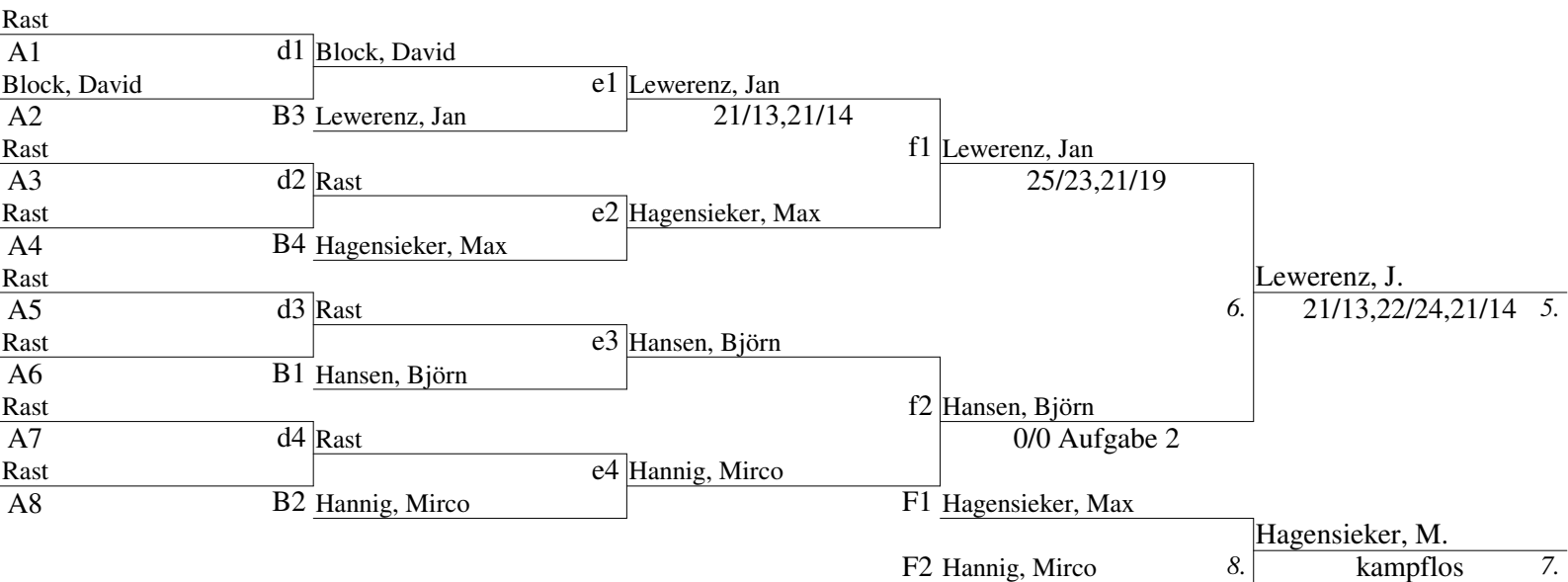
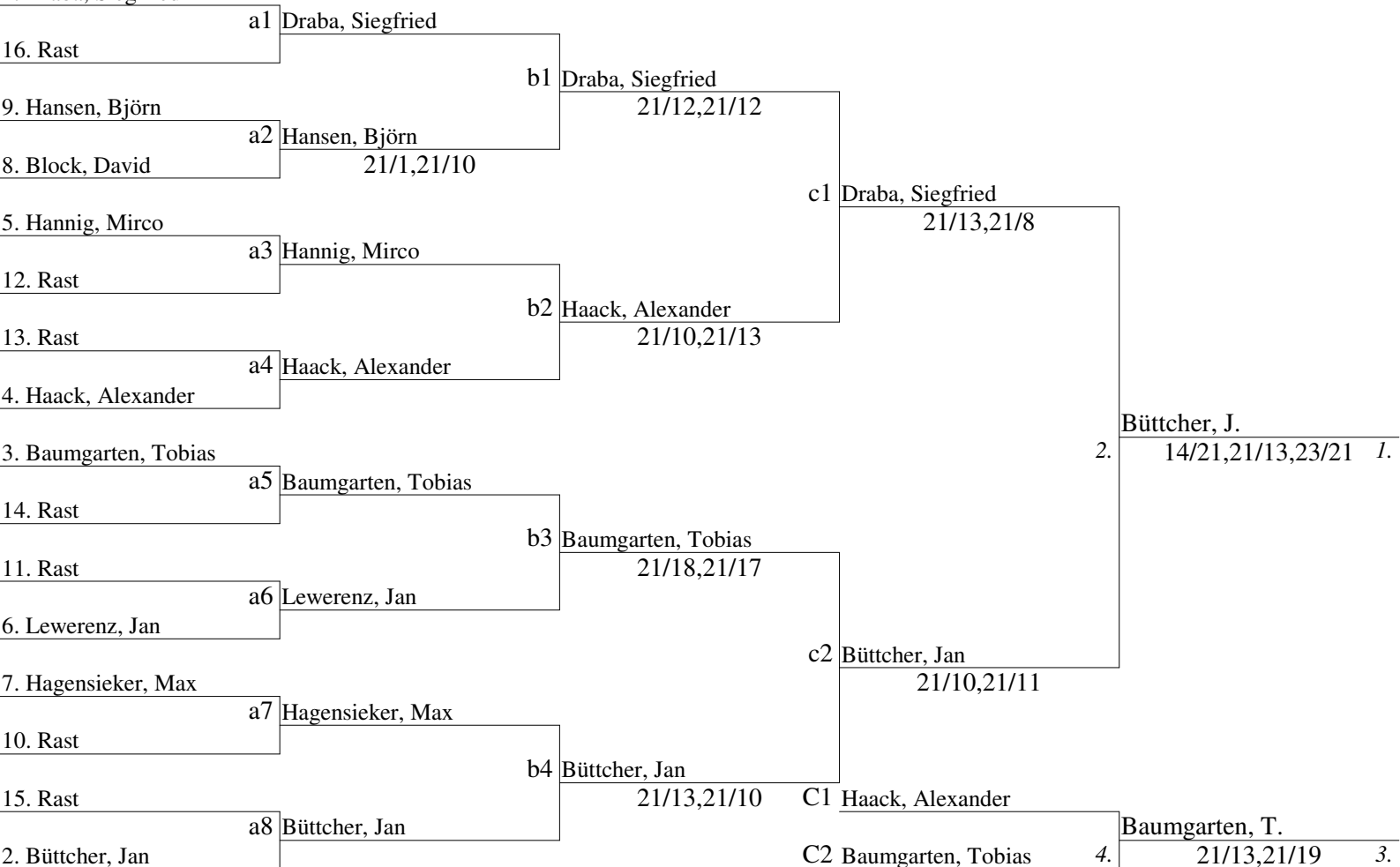

1. Kohnke, Lisann

16. Rast	a1	Kohnke, Lisann				
9. Steinert, Linda			b1	Kohnke, Lisann	21/16,21/16	
8. Lindemann, Nele	a2	Lindemann, Nele			21/12,21/9	
5. Schwaneberg, Jacqueline						c1 Kohnke, Lisann
12. Küchenthal, Jasmin	a3	Schwaneberg, Jacqueline			21/7,21/15	21/13,21/14
13. Jacobs, Sophie			b2	Grundmann, Jana	24/22,21/19	
4. Grundmann, Jana	a4	Grundmann, Jana			21/5,21/6	
3. Geisler, Jacqueline						2. Kohnke, L.
14. Lohse, Martha	a5	Geisler, Jacqueline			21/3,21/6	21/18,21/11 1.
11. Kirchner, Nadja			b3	Kurowski, Laura	16/21,23/21,21/19	
6. Kurowski, Laura	a6	Kurowski, Laura			21/6,21/10	
7. Schimmel, Melina						c2 Kurowski, Laura
10. Koch, Iris	a7	Schimmel, Melina			21/12,21/10	21/12,21/7
15. Lottje, Inka			b4	Voges, Laura	21/18,21/8	
2. Voges, Laura	a8	Voges, Laura			21/14,21/12	C1 Grundmann, Jana
						C2 Voges, Laura 4. Voges, L.
						19/21,21/18,21/17 3.

Rast

A1	d1	Steinert, Linda				
Steinert, Linda			e1	Geisler, Jacqueline	21/9,21/6	
A2	B3	Geisler, Jacqueline				
Küchenthal, Jasmin						f1 Geisler, Jacqueline
A3	d2	Küchenthal, Jasmin			21/7,21/12	
Jacobs, Sophie			e2	Schimmel, Melina	21/8,21/7	
A4	B4	Schimmel, Melina			21/19,21/11	
Lohse, Martha						6. Geisler, J.
A5	d3	Kirchner, Nadja			21/11,21/11	5.
Kirchner, Nadja			e3	Lindemann, Nele	21/8,21/9	
A6	B1	Lindemann, Nele			21/3,21/8	
Koch, Iris						f2 Schwaneberg, Jacqueline
A7	d4	Lottje, Inka			21/12,23/21	
Lottje, Inka			e4	Schwaneberg, Jacqueline	14/21,21/16,22/20	
A8	B2	Schwaneberg, Jacqueline				F1 Schimmel, Melina
						F2 Lindemann, Nele 8. Lindemann, N.
						21/17,21/9 7.

Steinert, L.
11. 21/17,21/16

12. Kirchner, Nadja			E1	Steinert, Linda		
			E2	Küchenthal, Jasmin	21/16,21/19	
			E3	Kirchner, Nadja		10. Küchenthal, J.
			E4	Lottje, Inka	21/18,21/11	9.
					21/13,21/13	
			D1	Rast		
Jacobs, S. 15.						
			D3	Lohse, Martha		
						14. Koch, I.
			D2	Jacobs, Sophie	21/12,21/9	13.
			D4	Koch, Iris	21/15,21/10	

	Draba, S./Büttcher, J.	Haack, A./Lewerenz, J.	Hagensieker, M./Hansen, B.	Block, D./Hannig, M.
Draba, S./Büttcher, J.	23/21,9/21,5/21	21/23,21/9,21/5	21/15,21/16	kampflos gew.
Haack, A./Lewerenz, J.	23/21,9/21,5/21	21/7,21/18	7/21,18/21	kampflos gew.
Hagensieker, M./Hansen, B.	15/21,16/21	21/7,21/18	kampflos verl.	kampflos gew.
Block, D./Hannig, M.	kampflos verl.	kampflos verl.	kampflos verl.	kampflos gew.
Punkte	147 : 68	104 : 105	115 : 67	0 : 126
Sätze	6 : 1	3 : 4	4 : 2	0 : 6
Spiele	3 : 0	1 : 2	2 : 1	0 : 3
Platz	1.	3.	2.	4.

1. Runde	1. Draba, S./Büttcher, J.	4. Block, D./Hannig, M.	kampflos an 1
	2. Haack, A./Lewerenz, J.	3. Hagensieker, M./Hansen, B.	7/21,18/21
2. Runde	Haack, A./Lewerenz, J.	Block, D./Hannig, M.	kampflos an 1
	Hagensieker, M./Hansen, B.	Draba, S./Büttcher, J.	15/21,16/21
3. Runde	Block, D./Hannig, M.	Hagensieker, M./Hansen, B.	kampflos an 2
	Draba, S./Büttcher, J.	Haack, A./Lewerenz, J.	21/23,21/9,21/5

1. Schwaneberg, J./Jürgens, C.	a1	Schwaneberg, J./Jürgens, C.			
16. Rast			b1	Schwaneberg, J./Jürgens, C.	
9. Lottje, I./Jacobs, S.				18/21,21/18,21/10	
8. Schimmel, M./Kumpf, S.	a2	Schimmel, M./Kumpf, S.			
		21/9,21/17			
5. Lindemann, N./Pohl, C.			c1	Geisler, J./Kurowski, L.	
12. Rast	a3	Lindemann, N./Pohl, C.		21/16,21/11	
13. Rast			b2	Geisler, J./Kurowski, L.	
				21/15,22/20	
4. Geisler, J./Kurowski, L.	a4	Geisler, J./Kurowski, L.			
3. Küchenthal, J./Grundmann, J.					2. Schumann, K./Kohnke, L.
14. Rast	a5	Küchenthal, J./Grundmann, J.			21/5,21/15
11. Rast			b3	Küchenthal, J./Grundmann, J.	
				21/11,21/14	
6. Roudsarabi, I./Kirchner, N.	a6	Roudsarabi, I./Kirchner, N.			
7. Voges, L./Lohse, M.			c2	Schumann, K./Kohnke, L.	
10. Steinert, L./Koch, I.	a7	Steinert, L./Koch, I.		21/6,21/10	
		21/17,23/21			
15. Rast			b4	Schumann, K./Kohnke, L.	
2. Schumann, K./Kohnke, L.	a8	Schumann, K./Kohnke, L.		21/10,21/7	
			C1	Schwaneberg, J./Jürgens, C.	
			C2	Küchenthal, J./Grundmann, J.	17/21,21/9,21/6
Rast					3. Schwaneberg, J./Jürgens, C.
A1	d1	Lottje, I./Jacobs, S.			
Lottje, I./Jacobs, S.			e1	Lottje, I./Jacobs, S.	
A2	B3	Roudsarabi, I./Kirchner, N.		21/13,21/13	
Rast					
A3	d2	Rast	f1	Steinert, L./Koch, I.	
Rast				21/13,21/18	
A4	B4	Steinert, L./Koch, I.			
Rast					
A5	d3	Rast			6. Lindemann, N./Pohl, C.
Rast			e3	Schimmel, M./Kumpf, S.	21/14,21/10
A6	B1	Schimmel, M./Kumpf, S.			
Voges, L./Lohse, M.			f2	Lindemann, N./Pohl, C.	
A7	d4	Voges, L./Lohse, M.		21/18,21/17	
Rast			e4	Lindemann, N./Pohl, C.	
A8	B2	Lindemann, N./Pohl, C.		21/9,21/12	
			F1	Lottje, I./Jacobs, S.	
			F2	Schimmel, M./Kumpf, S.	8. Schimmel, M./Kumpf, S.
					21/17,21/16
			E1	Roudsarabi, I./Kirchner, N.	
Rast					
			E2	Rast	
Rast					
11.	12.		E3	Rast	10. Voges, L./Lohse, M.
	Rast				21/15,13/21,21/17
			E4	Voges, L./Lohse, M.	
			D1	Rast	
Rast					
			D3	Rast	
Rast					
15.	16.		D2	Rast	14. Rast
	Rast				13.
			D4	Rast	

1. Draba, S./Kohnke, L.

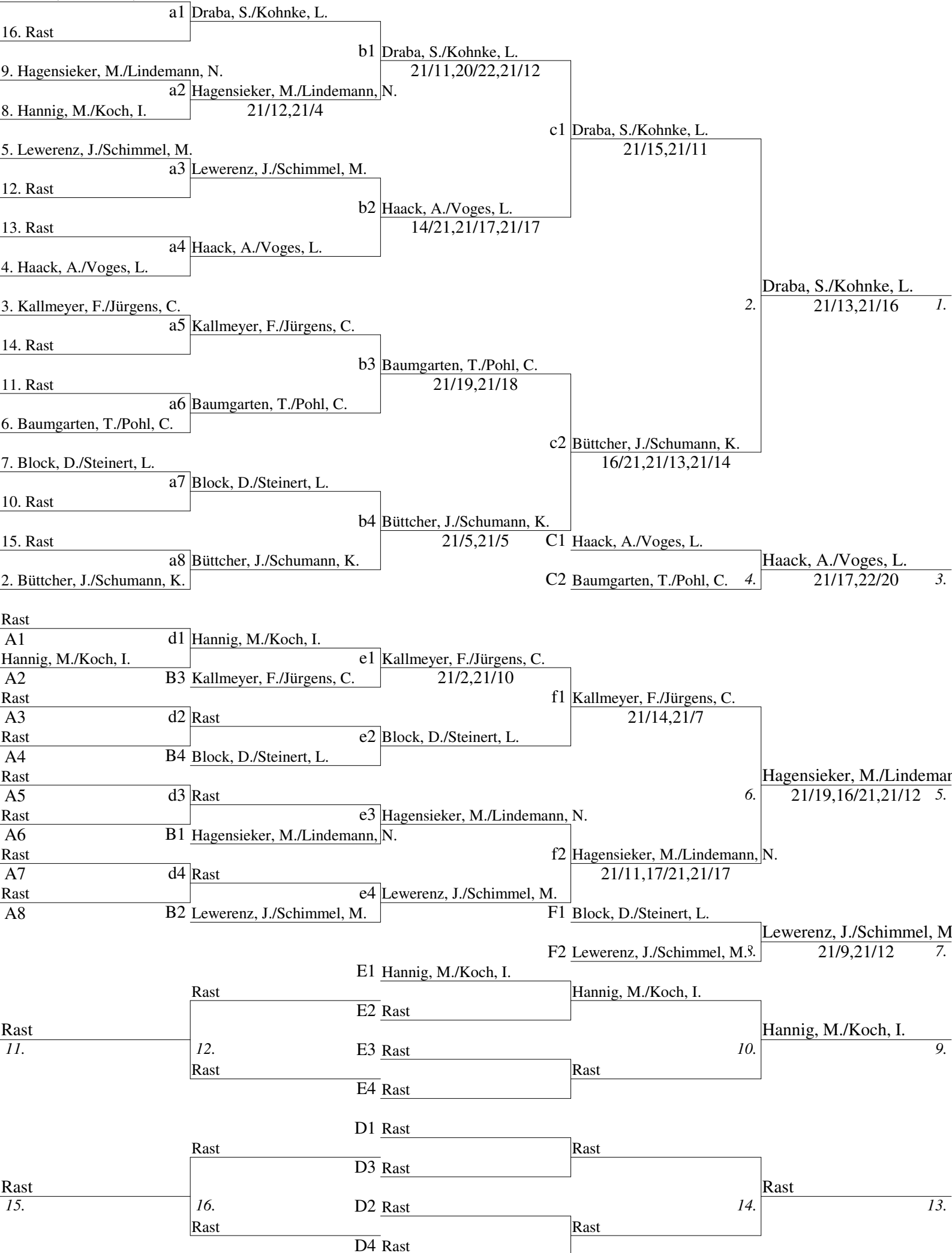

Stadtmeisterschaften BS 2011 - JE U19

Ausrichter : Badminton SFV BS e.V.

	Zabicki, M.	Klömpkes, A.	Witte, J.
Zabicki, M.		21/6,21/9	21/2,21/4
Klömpkes, A.	6/21,9/21		21/7,21/5
Witte, J.	2/21,4/21	7/21,5/21	
Punkte	84 : 21	57 : 54	18 : 84
Sätze	4 : 0	2 : 2	0 : 4
Spiele	2 : 0	1 : 1	0 : 2
Platz	1.	2.	3.

1. Runde	1. Zabicki, Martin	3. Witte, Jonas	21/2,21/4
2. Runde	2. Klömpkes, Aaron	3. Witte, Jonas	21/7,21/5
3. Runde	1. Zabicki, Martin	2. Klömpkes, Aaron	21/6,21/9

	Bettermann, L.	Kemper, I.	Fernkorn, J.	Linnenkohl, K.	Bettermann, S.	Dentzel, M.
Bettermann, L.		21/12,21/17	21/17,19/21,21/17	10/21,14/21	21/17,21/18	21/6,21/4
Kemper, I.	12/21,17/21		15/21,20/22	15/21,14/21	21/17,21/12	21/5,21/8
Fernkorn, J.	17/21,21/19,17/21	21/15,22/20		10/21,9/21	21/17,10/21,20/22	21/4,21/8
Linnenkohl, K.	21/10,21/14	21/15,21/14	21/10,21/9		21/9,21/7	21/6,21/10
Bettermann, S.	17/21,18/21	17/21,12/21	17/21,21/10,22/20	9/21,7/21		21/4,21/7
Dentzel, M.	6/21,4/21	5/21,8/21	4/21,8/21	6/21,10/21	4/21,7/21	
Punkte	211 : 171	177 : 169	210 : 210	210 : 104	182 : 188	62 : 210
Sätze	8 : 3	4 : 6	6 : 6	10 : 0	4 : 7	0 : 10
Spiele	4 : 1	2 : 3	2 : 3	5 : 0	2 : 3	0 : 5
Platz	2.	4.	3.	1.	5.	6.

1. Runde	1. Bettermann, Lea	6. Dentzel, Madlin	21/6,21/4
	2. Kemper, Isabel	5. Bettermann, Svenja	21/17,21/12
	3. Fernkorn, Jana	4. Linnenkohl, Kathrin	10/21,9/21
2. Runde	Fernkorn, Jana	Dentzel, Madlin	21/4,21/8
	Linnenkohl, Kathrin	Kemper, Isabel	21/15,21/14
	Bettermann, Svenja	Bettermann, Lea	17/21,18/21
3. Runde	Dentzel, Madlin	Bettermann, Svenja	4/21,7/21
	Bettermann, Lea	Linnenkohl, Kathrin	10/21,14/21
	Kemper, Isabel	Fernkorn, Jana	15/21,20/22
4. Runde	Kemper, Isabel	Dentzel, Madlin	21/5,21/8
	Fernkorn, Jana	Bettermann, Lea	17/21,21/19,17/21
	Linnenkohl, Kathrin	Bettermann, Svenja	21/9,21/7
5. Runde	Dentzel, Madlin	Linnenkohl, Kathrin	6/21,10/21
	Bettermann, Svenja	Fernkorn, Jana	17/21,21/10,22/20
	Bettermann, Lea	Kemper, Isabel	21/12,21/17

Stadtmeisterschaften BS 2011 - JD+HD U19+U22

Ausrichter : Badminton SFV BS e.V.

	Zabicki, M./Witte, J.	Haack, C./Barthélèmy, V.	Klömpkes, A./Künne, R.
Zabicki, M./Witte, J.		22/20,21/17	21/19,17/21,20/22
Haack, C./Barthélèmy, V.	20/22,17/21		8/21,8/21
Klömpkes, A./Künne, R.	19/21,21/17,22/20	21/8,21/8	
Punkte	101 : 99	53 : 85	104 : 74
Sätze	3 : 2	0 : 4	4 : 1
Spiele	1 : 1	0 : 2	2 : 0
Platz	2.	3.	1.

1. Runde	1. Zabicki, M./Witte, J.	3. Klömpkes, A./Künne, R.	21/19,17/21,20/22
2. Runde	2. Haack, C./Barthélèmy, V.	3. Klömpkes, A./Künne, R.	8/21,8/21
3. Runde	1. Zabicki, M./Witte, J.	2. Haack, C./Barthélèmy, V.	22/20,21/17

Stadtmeisterschaften BS 2011 - MD+DD U19+U22

Ausrichter : Badminton SFV BS e.V.

	Dunst, A./Ermgassen, J.	Linnenkohl, K./Dentzel, M.	Bettermann, S./Bettermann, L.
Dunst, A./Ermgassen, J.		23/25,18/21	15/21,4/21
Linnenkohl, K./Dentzel, M.	25/23,21/18		21/19,17/21,18/21
Bettermann, S./Bettermann, L.	21/15,21/4	19/21,21/17,21/18	
Punkte	60 : 88	102 : 102	103 : 75
Sätze	0 : 4	3 : 2	4 : 1
Spiele	0 : 2	1 : 1	2 : 0
	3.	2.	1.

Platz

1. Runde	1. Dunst, A./Ermgassen, J.	3. Bettermann, S./Bettermann, L.	15/21,4/21
2. Runde	2. Linnenkohl, K./Dentzel, M.	3. Bettermann, S./Bettermann, L.	21/19,17/21,18/21
3. Runde	1. Dunst, A./Ermgassen, J.	2. Linnenkohl, K./Dentzel, M.	23/25,18/21

	Maring, C.	Künne, R.	Haack, C.	Barthélèmy, V.	Rui, J.	Rast
Maring, C.		21/13,21/8	21/7,21/6	21/8,21/4	21/6,21/4	
Künne, R.	13/21,8/21		21/7,21/8	21/11,21/17	21/4,21/2	
Haack, C.	7/21,6/21	7/21,8/21		9/21,7/21	21/14,6/21,14/21	
Barthélèmy, V.	8/21,4/21	11/21,17/21	21/9,21/7		21/4,21/13	
Rui, J.	6/21,4/21	4/21,2/21	14/21,21/6,21/14	4/21,13/21		
Rast						
Punkte	168 : 56	147 : 91	85 : 182	124 : 117	89 : 167	
Sätze	8 : 0	6 : 2	1 : 8	4 : 4	2 : 7	
Spiele	4 : 0	3 : 1	0 : 4	2 : 2	1 : 3	
Platz	1.	2.	5.	3.	4.	

1. Runde	1. Maring, Christian	6. Rast	
	2. Künne, Robin	5. Rui, Jon	21/4,21/2
	3. Haack, Christian	4. Barthélèmy, Vincent	9/21,7/21
2. Runde	Haack, Christian	Rast	
	Barthélèmy, Vincent	Künne, Robin	11/21,17/21
	Rui, Jon	Maring, Christian	6/21,4/21
3. Runde	Rast	Rui, Jon	
	Maring, Christian	Barthélèmy, Vincent	21/8,21/4
	Künne, Robin	Haack, Christian	21/7,21/8
4. Runde	Künne, Robin	Rast	
	Haack, Christian	Maring, Christian	7/21,6/21
	Barthélèmy, Vincent	Rui, Jon	21/4,21/13
5. Runde	Rast	Barthélèmy, Vincent	
	Rui, Jon	Haack, Christian	14/21,21/6,21/14
	Maring, Christian	Künne, Robin	21/13,21/8

	Patzelt, M./Kemper, I.	Rui, J./Fernkorn, J.	Haack, C./Dentzel, M.	Barthélèmy, V./Grundmann, J.	Maring, C./Bettermann, L.	Künne, R./Bettermann, S.
Patzelt, M./Kemper, I.		21/12,21/6	21/4,21/6	21/14,21/9	21/16,21/13	21/18,21/14
Rui, J./Fernkorn, J.	12/21,6/21		21/13,21/12	18/21,13/21	8/21,15/21	7/21,8/21
Haack, C./Dentzel, M.	4/21,6/21	13/21,12/21		4/21,10/21	9/21,13/21	3/21,16/21
Barthélèmy, V./Grundmann, J.	14/21,9/21	21/18,21/13	21/4,21/10		14/21,17/21	21/14,21/18
Maring, C./Bettermann, L.	16/21,13/21	21/8,21/15	21/9,21/13	21/14,21/17		21/18,21/12
Künne, R./Bettermann, S.	18/21,14/21	21/7,21/8	21/3,21/16	14/21,18/21	18/21,12/21	
Punkte	210 : 112	129 : 193	90 : 210	180 : 161	197 : 148	178 : 160
Sätze	10 : 0	2 : 8	0 : 10	6 : 4	8 : 2	4 : 6
Spiele	5 : 0	1 : 4	0 : 5	3 : 2	4 : 1	2 : 3
Platz	1.	5.	6.	3.	2.	4.

1. Runde	1. Patzelt, M./Kemper, I.	6. Künne, R./Bettermann, S.	21/18,21/14
	2. Rui, J./Fernkorn, J.	5. Maring, C./Bettermann, L.	8/21,15/21
	3. Haack, C./Dentzel, M.	4. Barthélèmy, V./Grundmann, J.	4/21,10/21
2. Runde	Haack, C./Dentzel, M.	Künne, R./Bettermann, S.	3/21,16/21
	Barthélèmy, V./Grundmann, J.	Rui, J./Fernkorn, J.	21/18,21/13
	Maring, C./Bettermann, L.	Patzelt, M./Kemper, I.	16/21,13/21
3. Runde	Künne, R./Bettermann, S.	Maring, C./Bettermann, L.	18/21,12/21
	Patzelt, M./Kemper, I.	Barthélèmy, V./Grundmann, J.	21/14,21/9
	Rui, J./Fernkorn, J.	Haack, C./Dentzel, M.	21/13,21/12
4. Runde	Rui, J./Fernkorn, J.	Künne, R./Bettermann, S.	7/21,8/21
	Haack, C./Dentzel, M.	Patzelt, M./Kemper, I.	4/21,6/21
	Barthélèmy, V./Grundmann, J.	Maring, C./Bettermann, L.	14/21,17/21
5. Runde	Künne, R./Bettermann, S.	Barthélèmy, V./Grundmann, J.	14/21,18/21
	Maring, C./Bettermann, L.	Haack, C./Dentzel, M.	21/9,21/13
	Patzelt, M./Kemper, I.	Rui, J./Fernkorn, J.	21/12,21/6